

SK 15 GD 126 ET

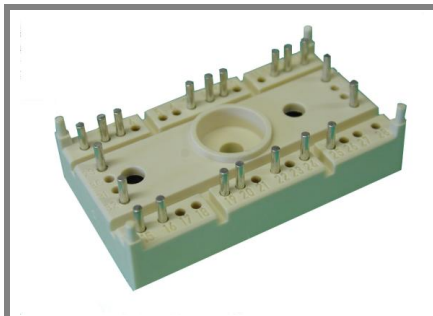

SEMITOP[®] 3

3-phase bridge inverter

SK 15 GD 126 ET

Preliminary Data

Features

- Compact design
- One screw mounting
- Heat transfer and isolation through direct copper bonded aluminum oxide ceramic (DCB)
- Trench technology IGBT
- CAL High Density FWD
- Integrated NTC temperature sensor

Typical Applications

- Inverter

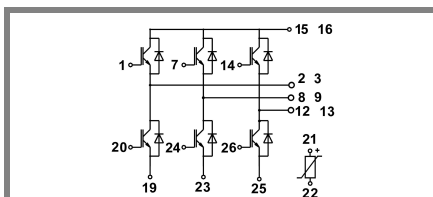

GD - ET

Absolute Maximum Ratings		$T_s = 25^\circ\text{C}$, unless otherwise specified	
Symbol	Conditions	Values	Units
IGBT - Inverter, Chopper			
V_{CES}		1200	V
I_C	$T_s = 25 (80)^\circ\text{C}$	22 (15)	A
I_{CM}	$T_s = 25 (80)^\circ\text{C}$, $t_p \leq 1 \text{ ms}$	44 (30)	A
V_{GES}		± 20	V
T_j		-40 ... +150	$^\circ\text{C}$
Diode - Inverter, Chopper			
I_F	$T_s = 25 (80)^\circ\text{C}$	25 (17)	A
$I_{FM} = -I_{CM}$	$T_s = 25 (80)^\circ\text{C}$, $t_p \leq 1 \text{ ms}$	50 (34)	A
T_j		-40 ... +150	$^\circ\text{C}$
Rectifier			
V_{RRM}			V
I_{FAV} / I_{TAV}	$T_s = ^\circ\text{C}$		A
I_{FSM} / I_{TSM}	$t_p = \text{ms}$, \sin° , $T_j = ^\circ\text{C}$		A
I_t^2	$t_p = \text{ms}$, \sin° , $T_j = ^\circ\text{C}$		A^2s
T_j			$^\circ\text{C}$
T_{sol}	Terminals, 10s	260	$^\circ\text{C}$
T_{stg}		-40, ... +125	$^\circ\text{C}$
V_{isol}	AC, 1 min. / 1s	2500 / 3000	V

Characteristics		$T_s = 25^\circ\text{C}$, unless otherwise specified			
Symbol	Conditions	min.	typ.	max.	Units
IGBT - Inverter, Chopper					
V_{CEsat}	$I_C = 15 \text{ A}$, $T_j = 25 (125)^\circ\text{C}$		1,7 (2,2)	2,1	V
$V_{GE(th)}$	$V_{GE} = V_{CE}$, $I_C = 0,6 \text{ mA}$	5	5,8	6,5	V
$V_{CE(TO)}$	$T_j = 25^\circ\text{C}$ (125) $^\circ\text{C}$		1 (0,9)	1,2	V
r_T	$T_j = 25^\circ\text{C}$ (125) $^\circ\text{C}$		47 (73)	60	m Ω
C_{ies}	$V_{CE} = 25 \text{ V}$, $V_{GE} = 0 \text{ V}$, $f = 1 \text{ MHz}$		1,2		nF
C_{oes}	$V_{CE} = 25 \text{ V}$, $V_{GE} = 0 \text{ V}$, $f = 1 \text{ MHz}$		0,3		nF
C_{res}	$V_{CE} = 25 \text{ V}$, $V_{GE} = 0 \text{ V}$, $f = 1 \text{ MHz}$		0,2		nF
$R_{th(j-s)}$	per IGBT			1,6	K/W
$t_{d(on)}$	under following conditions		35		ns
t_r	$V_{CC} = 600 \text{ V}$, $V_{GE} = \pm 15 \text{ V}$		20		ns
$t_{d(off)}$	$I_C = 15 \text{ A}$, $T_j = 125^\circ\text{C}$		403		ns
t_f	$R_{Gon} = R_{Goff} = 50 \Omega$		192		ns
E_{on}	inductive load		1,63		mJ
E_{off}			1,93		mJ
Diode - Inverter, Chopper					
$V_F = V_{EC}$	$I_F = 15 \text{ A}$, $T_j = 25 (125)^\circ\text{C}$		1,6 (1,6)	1,8	V
$V_{(TO)}$	$T_j = 25^\circ\text{C}$ (125) $^\circ\text{C}$		1 (0,8)	1,1	V
r_T	$T_j = 25^\circ\text{C}$ (125) $^\circ\text{C}$		40 (53)	47	m Ω
$R_{th(j-s)}$	per diode			2,1	K/W
I_{RRM}	under following conditions		21		A
Q_{rr}	$I_F = 15 \text{ A}$, $V_R = 600 \text{ V}$		3,5		μC
E_{rr}	$V_{GE} = 0 \text{ V}$, $T_j = 125^\circ\text{C}$		1,4		mJ
	$di_F/dt = 570 \text{ A}/\mu\text{s}$				
Diode rectifier					
V_F	$I_F = \text{A}$, $T_j = 25^\circ\text{C}$				V
$V_{(TO)}$	$T_j = ^\circ\text{C}$				V
r_T	$T_j = ^\circ\text{C}$				m Ω
$R_{th(j-s)}$	per diode				K/W
Temperatur sensor					
R_{ts}	5 %, $T_r = 25 (100)^\circ\text{C}$		5000(493)		Ω
Mechanical data					
w			30		g
M_s	Mounting torque			2,5	Nm

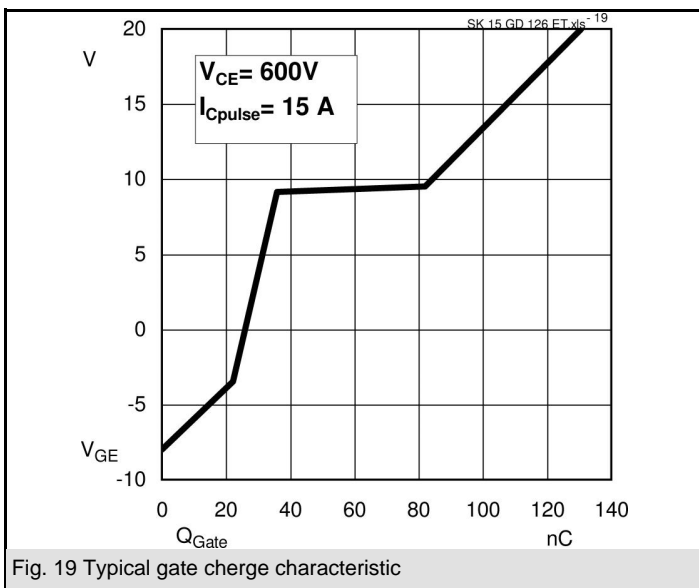
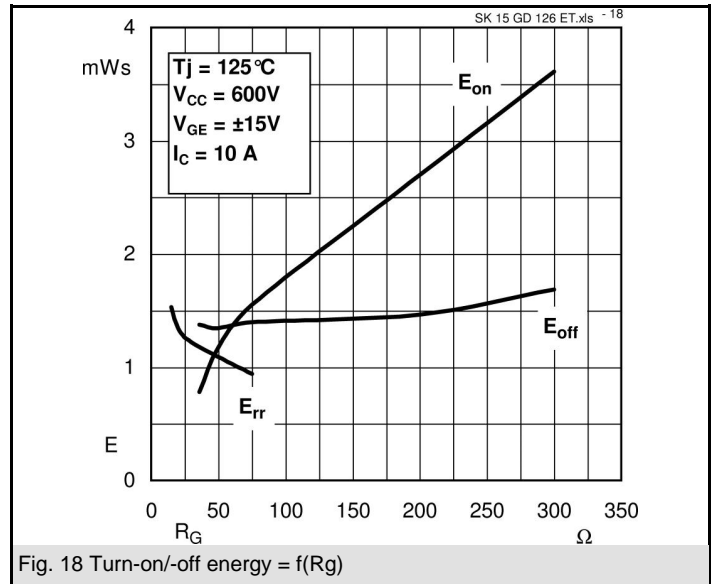
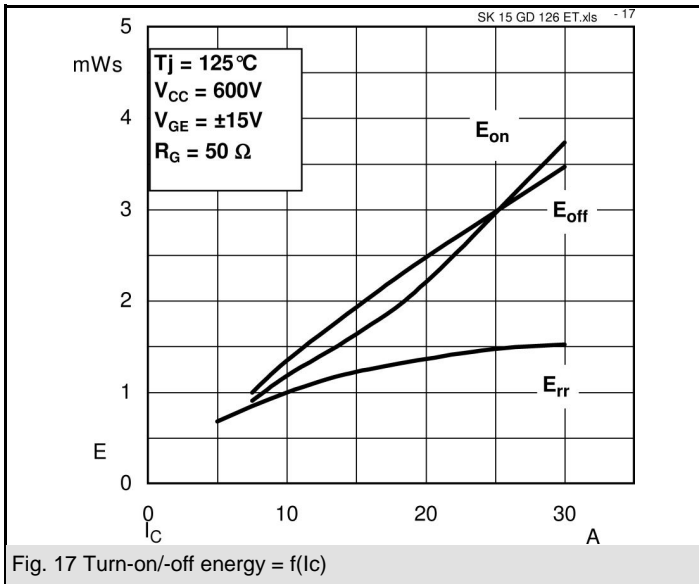
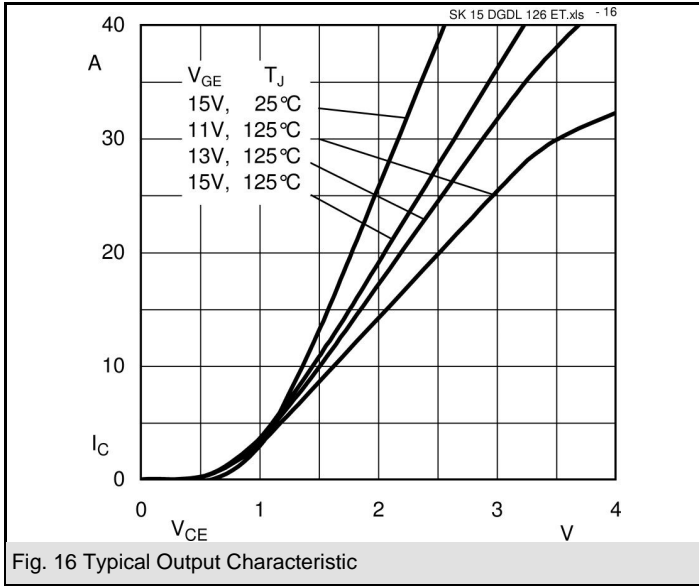

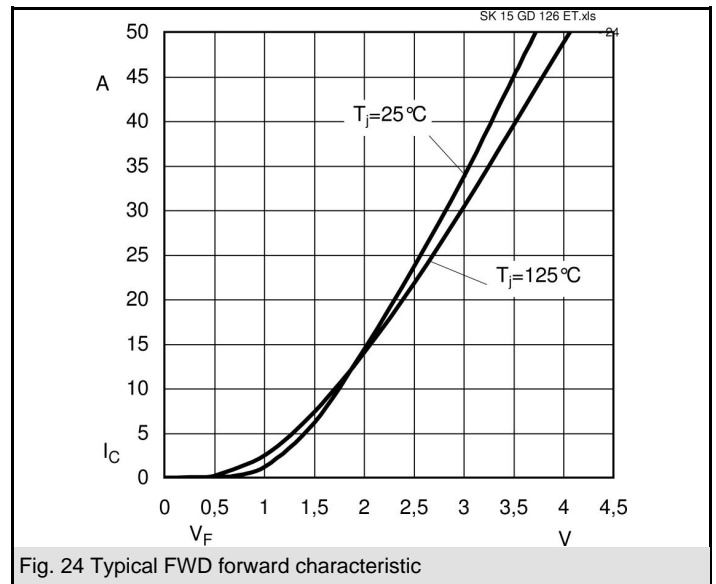
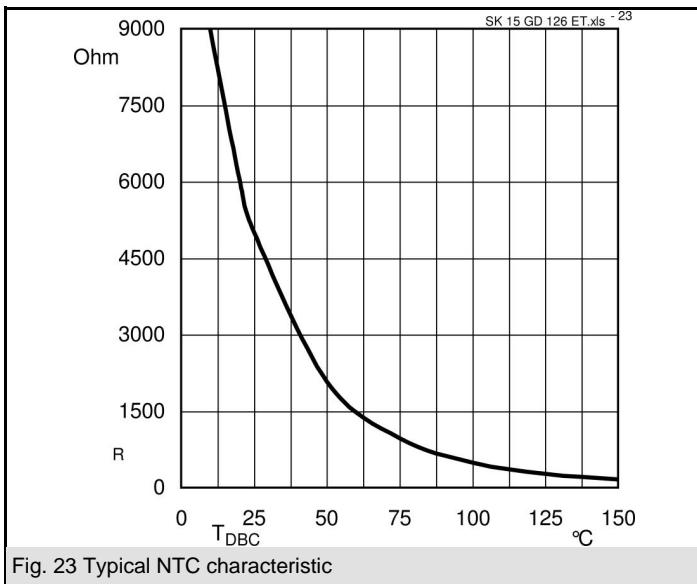
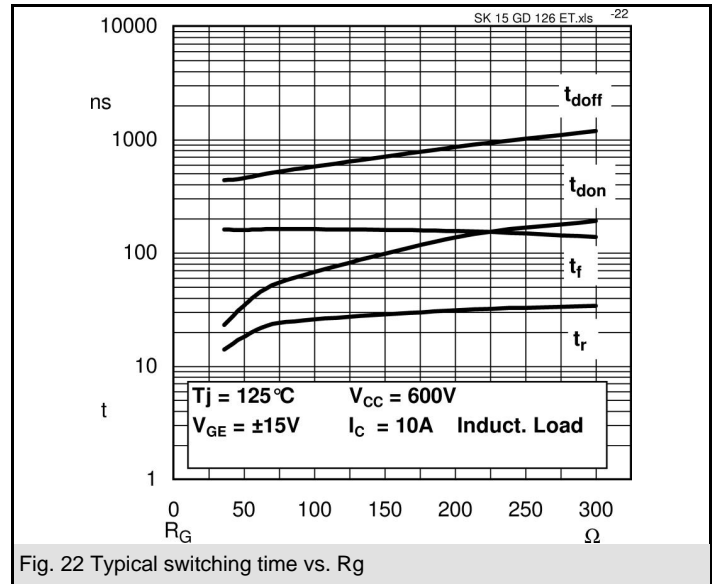
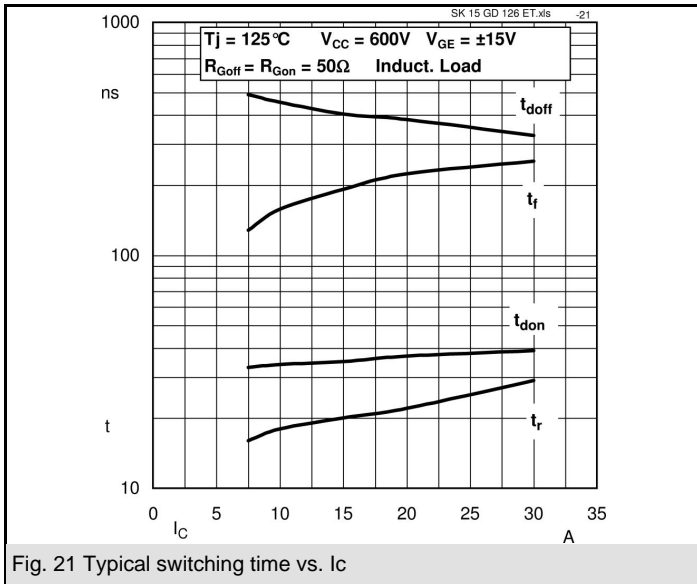

SK 15 GD 126 ET

UL Recognized
File no. E63 532

Dimensions in mm

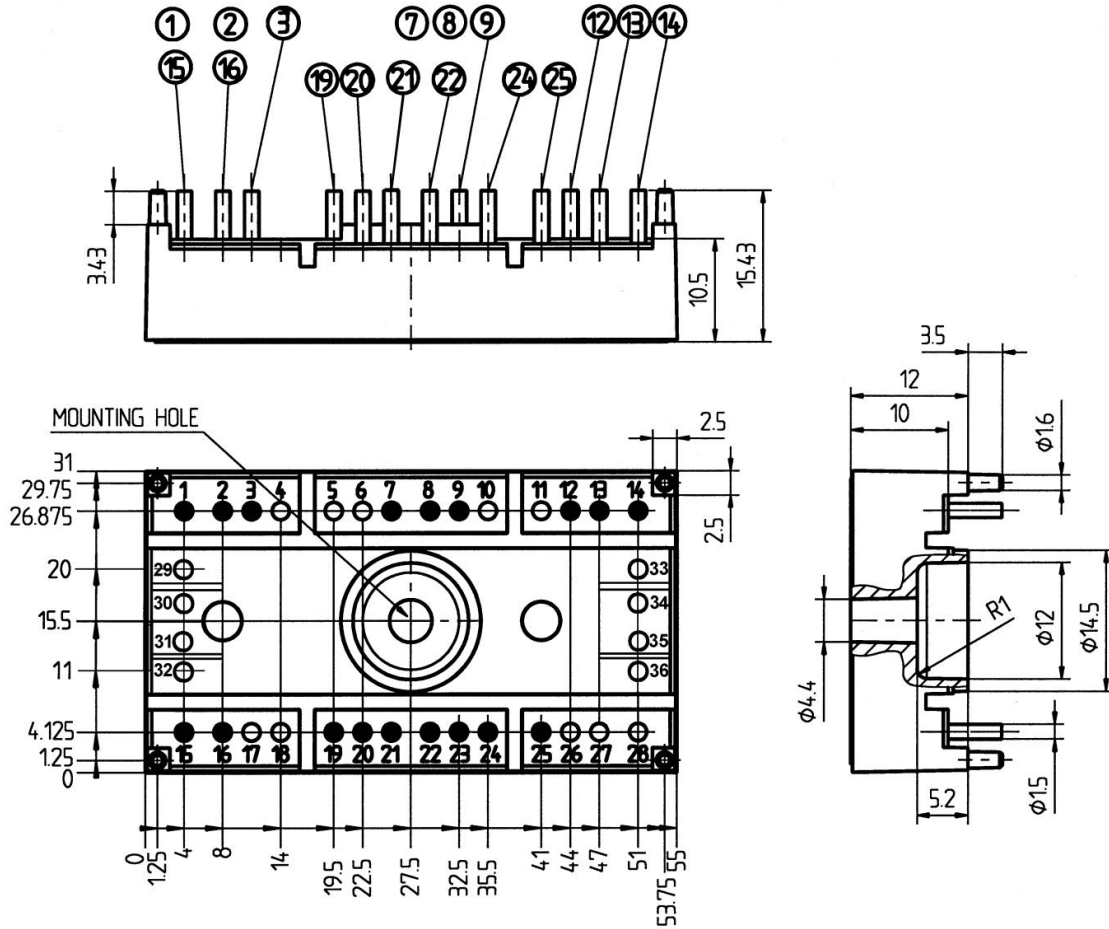

Case T 52 (Suggested hole diameter, in the PCB, for solder pins and plastic mounting pins: 2mm)

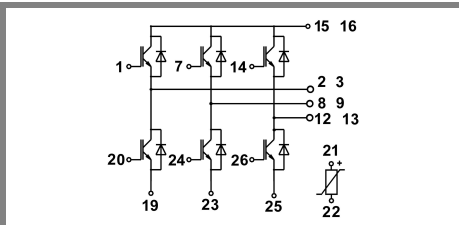

Case T 52

This is an electrostatic discharge sensitive device (ESDS), international standard IEC 60747-1, Chapter IX.

This technical information specifies semiconductor devices but promises no characteristics. No warranty or guarantee expressed or implied is made regarding delivery, performance or suitability.